

IMPORTANT NOTIFICATION

In order to focus on our core business,
Concepts will no longer be offering Ear Piercing Products.
We are providing this previously written manual to assist in this transition.

For use of the Studex Universal Instrument,
Please refer to Studex for Manuals & Videos:
studex.com 1-800-478-8339 or 1-310-851-9300



Ear Piercing INSTRUCTIONS

IMPORTANT:

Be sure to confirm with your Town or City, State and County Health Department that no additional restrictions, license or permit is required to offer ear piercing in your area. If so, follow the additional processes to ensure you are compliant with your local health department.

**Made in
the USA**

CONCEPT MARKETING, INC. • 1000 Arendell Street • Morehead City, NC 28557 US
www.conceptsjewelry.com • info@conceptsjewelry.com • Text: 1-252-723-2234
Fax: 1-800-247-7290 • **Phone: 1-800-926-3277**

IMPORTANT NOTIFICATION

**In order to focus on our core business,
Concepts will no longer be offering Ear Piercing Products.**

We are providing this previously written manual to assist in this transition.

For use of the Studex Universal Instrument,
Please refer to Studex for Manuals & Videos:
studex.com 1-800-478-8339 or 1-310-851-9300

Replacement Universal Studex instruments
may be purchased directly from Studex:
1-800-478-8339 or
1-310-851-9300
www.studex.com

READ PRIOR TO PIERCING Statement of Release

In order to focus on our core business, Concepts will no longer be offering Ear Piercing Products. For use of the Studex Universal Instrument, Please refer to Studex for Manuals & Videos: studex.com 1-800-478-8339 or 1-310-851-9300

You must obtain a legally Signed Release Form prior to piercing:

Customer must be able to legally sign the release form, being their own legal guardian 18 years of age or older; under 18 years signed by their legal guardian. As with anything, there is a possibility that the earring or instrument may malfunction or other problems may occur when performing ear piercing. Concept Marketing, Inc. packaged and sterilized ear piercing earrings manufactured by Studex and offered the Studex Universal instrument. Concept Marketing, Inc. (Concepts / Concept) is not responsible for malfunction of earring, instrument or any other problems that may occur due to ear piercing. Please see Release Form 'original' on the next page.

Additions to Ear Piercing Manual:

1.) Keep on Hand:

a.) Sterilized Gauze Pads for Wound Care b.) 70% Isopropyl Alcohol c.) Cotton Swabs d.) Medical Gloves

2.) Test Earring fit to Adapter Before Using

Insert earring into Adapter without removing from wand, pull earring in & out a few times to make sure it comes out easily.

IF Earring does not easily go in & out of the instrument do not use earring. If several different styles fit too snugly in the instrument, please contact Studex for replacement instrument: 1-800-478-8339 www.studex.com

3.) IF Earring becomes stuck in the Adapter:

Pull back the silver Plunger Knob (See Figure A Below.) This should either remove the earring from the instrument or earlobe. *If earring removal is still prevented by back not releasing, you can remove the Adapter from the instrument and then remove the back & earring.* (See Below: How to Remove Adapter.) Earlobe may bleed. Use Sterilized Gauze Pads to stop the bleeding (applying pressure to the piercing area.) When bleeding subsides, clean wound area with Ear Magic or Isopropyl alcohol. **Do not continue to use that instrument or style of earrings.** At your own discretion, you may choose to re-pierce or have customer return for re-piercing using a different instrument and different style of earring that you have triple checked the fit (Step 2 above.) Please contact Studex for replacement instrument: 1-800-478-8339 www.studex.com

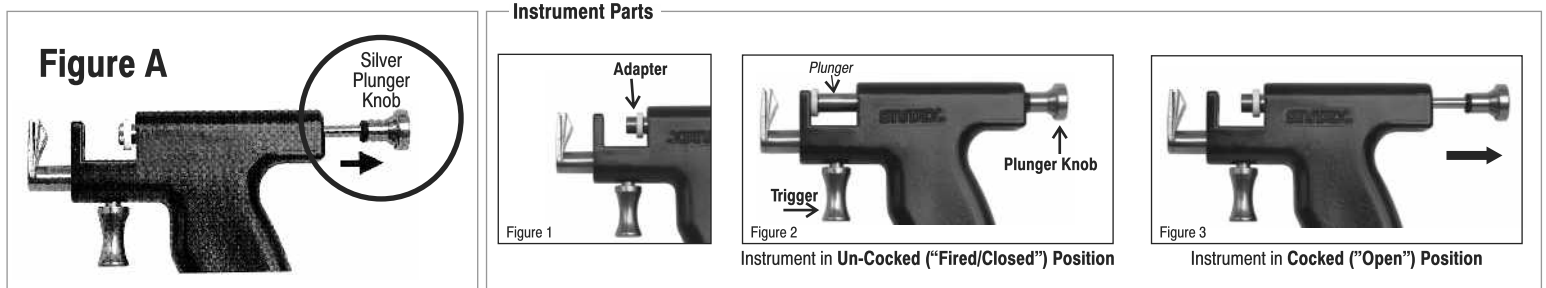

How to Remove Adapter

To remove the adapter you can pull forward on the white ring or you can put the instrument into the un-cocked ("Fired or Closed") position by pulling the Trigger. (Figure 2) Then while holding the Trigger in, pull back on the Plunger Knob and the Adapter will either pop out or be in a position to easily pull out. (Figures 4 & 5)

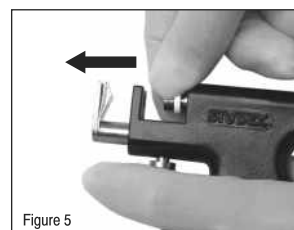
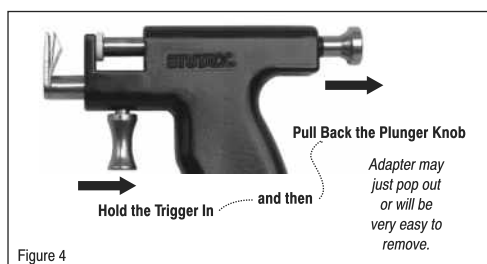

www.conceptsjewelry.com info@conceptsjewelry.com Phone: 1-800-926-3277

Concepts CONCEPT MARKETING, INC. 1000 Arendell Street Morehead City, NC 28557 US

Spare "Original" of Release Form to Copy if Needed

Remember to Always Get Signed Release Form &
Add Release Forms to Your Orders As Needed!!

www.conceptsjewelry.com info@conceptsjewelry.com Phone: 1-800-926-3277

Concepts CONCEPT MARKETING, INC. 1000 Arendell Street Morehead City, NC 28557 US



CUSTOMER RELEASE AUTHORIZATION

The undersigned in consideration of services, including without limitation the piercing of ears to hold jewelry, and other good and valuable consideration the receipt of which are hereby acknowledged, covenants not to sue, and does release, acquit, and forever discharge jointly and severally, Concept Marketing, Inc.

_____ and _____
(Store Name) (Piercer)

and the agents of each, their heirs, legal representatives, successors and assigns, of and from all claims, liabilities, judgements or executions whatsoever arising out of or relating to any loss, damage or injury, including death, that have been or may be sustained by me, my property or children or wards, or persons under my supervision or control, as natural guardian or otherwise, against said Concept Marketing, Inc.,

_____ and _____
(Store Name) (Piercer)

which I ever had, now have or will ever have, or which my children, wards, persons under my supervision or control as natural guardian or otherwise, or my heirs, legal representatives, successors or assigns hereafter shall have for, upon or by reason of any matter, cause or thing whatsoever.

I, the undersigned, am aware of the risks and hazards inherent in ear piercing and other procedures involved therein, and do hereby elect voluntarily to undertake same, and hereby voluntarily consent to same and hereby voluntarily assume all risks and hazards of loss, or injury of any kind whatsoever that may be associated with same or sustained by the undersigned and my children or wards, or persons under my supervision, or control, as natural guardian, or otherwise as a result of any acts or failures to act on the part of all those released and discharged hereby.

In signing this Release, I hereby acknowledge and represent (a) that I have read the fore going Release, understand it, and sign it voluntarily; (b) that I am over the age of minority (if given on behalf of a minor, I am the parent or guardian of such minor or otherwise in a supervisory capacity); I am of sound mind; (c) that I am not an agent of the parties released and/or of their agents. This Release may not be changed orally.

IN WITNESS WHEREOF, I have hereunto
set my hand and seal, this _____ Day of _____, 2_____

Sealed and delivered in
the presence of:

(Customer) (Seal)

(Parent or Legal Guardian) (Seal)

(Address)

(Style & #) (City) (State/Province) (Zip/Postal)

PIERCED EAR CARE INSTRUCTIONS

FIRST 6-10 WEEKS: Clean twice daily with Concepts Ear Magic. Saturate cotton swab with Ear Magic. Push earring forward from the back to clean between earring & lobe. Push earring back to clean between back of lobe & earring back. Avoid touching lobes or twisting earrings throughout the day (only when cleaning.) **Leave studs in earlobes at all times; do not remove studs for the first 6-10 weeks.** This is the healing period for studs to form straight canals of correct size and prevents earring back from being too tight. Be careful to not snag earrings: on clothing, towels or by other means. Cosmetics, hair spray, perfumes, etc. SHOULD NOT come in contact with earlobes. Cover earlobes with hand or paper cup when using sprays. Clean after swimming, showering, heavy exercise, if lobes become soiled between cleaning and after touching earlobes.

"IN THE EVENT OF ANY COMPLICATIONS - SEE YOUR DOCTOR IMMEDIATELY"

After healing period: Do not go without earrings for the next 12 months or for any period of extended time after that. **Avoid wires for 6 months & always avoid heavier styles.** Continue to clean ears twice daily with Ear Magic. **Do not wear your earrings too tightly.** In case of injury/irritation, reinsert piercing studs until healed & consult your doctor. If Ear Magic is not available, please use isopropyl (Rubbing) alcohol.

CUSTOMER RELEASE AUTHORIZATION

The undersigned in consideration of services, including without limitation the piercing of ears to hold jewelry, and other good and valuable consideration the receipt of which are hereby acknowledged, covenants not to sue, and does release, acquit, and forever discharge jointly and severally, Concept Marketing, Inc.

_____ and _____
(Store Name) (Piercer)

and the agents of each, their heirs, legal representatives, successors and assigns, of and from all claims, liabilities, judgements or executions whatsoever arising out of or relating to any loss, damage or injury, including death, that have been or may be sustained by me, my property or children or wards, or persons under my supervision or control, as natural guardian or otherwise, against said Concept Marketing, Inc.,

_____ and _____
(Store Name) (Piercer)

which I ever had, now have or will ever have, or which my children, wards, persons under my supervision or control as natural guardian or otherwise, or my heirs, legal representatives, successors or assigns hereafter shall have for, upon or by reason of any matter, cause or thing whatsoever.

I, the undersigned, am aware of the risks and hazards inherent in ear piercing and other procedures involved therein, and do hereby elect voluntarily to undertake same, and hereby voluntarily consent to same and hereby voluntarily assume all risks and hazards of loss, or injury of any kind whatsoever that may be associated with same or sustained by the undersigned and my children or wards, or persons under my supervision, or control, as natural guardian, or otherwise as a result of any acts or failures to act on the part of all those released and discharged hereby.

In signing this Release, I hereby acknowledge and represent (a) that I have read the fore going Release, understand it, and sign it voluntarily; (b) that I am over the age of minority (if given on behalf of a minor, I am the parent or guardian of such minor or otherwise in a supervisory capacity); I am of sound mind; (c) that I am not an agent of the parties released and/or of their agents. This Release may not be changed orally.

IN WITNESS WHEREOF, I have hereunto
set my hand and seal, this _____ Day of _____, 2_____

Sealed and delivered in
the presence of:

(Customer) (Seal)

(Parent or Legal Guardian) (Seal)

(Address)

(Style & #) (City) (State/Province) (Zip/Postal)

PIERCED EAR CARE INSTRUCTIONS

FIRST 6-10 WEEKS: Clean twice daily with Concepts Ear Magic. Saturate cotton swab with Ear Magic. Push earring forward from the back to clean between earring & lobe. Push earring back to clean between back of lobe & earring back. Avoid touching lobes or twisting earrings throughout the day (only when cleaning.) **Leave studs in earlobes at all times; do not remove studs for the first 6-10 weeks.** This is the healing period for studs to form straight canals of correct size and prevents earring back from being too tight. Be careful to not snag earrings: on clothing, towels or by other means. Cosmetics, hair spray, perfumes, etc. SHOULD NOT come in contact with earlobes. Cover earlobes with hand or paper cup when using sprays. Clean after swimming, showering, heavy exercise, if lobes become soiled between cleaning and after touching earlobes.

"IN THE EVENT OF ANY COMPLICATIONS - SEE YOUR DOCTOR IMMEDIATELY"

After healing period: Do not go without earrings for the next 12 months or for any period of extended time after that. **Avoid wires for 6 months & always avoid heavier styles.** Continue to clean ears twice daily with Ear Magic. **Do not wear your earrings too tightly.** In case of injury/irritation, reinsert piercing studs until healed & consult your doctor. If Ear Magic is not available, please use isopropyl (Rubbing) alcohol.

In order to focus on our core business, Concepts will no longer be offering Ear Piercing Products.
We are providing this previously written manual to assist in this transition.
For use of the Studex Universal Instrument, Please refer to Studex for Manuals & Videos:
studex.com 1-800-478-8339 or 1-310-851-9300

Easy Ear Piercing

INSTRUCTIONS - Step by Step

1. Have your customer pick the style they would like for piercing.
2. While customer is making her or his selection, begin filling in the release form. (See Page Titled "CUSTOMER RELEASE FORM.) Instruct customer to fill in the needed information on the release form and sign. If customer is under eighteen years of age, they must be accompanied by a parent or guardian and release form must be signed by parent / legal guardian in the presence of the person performing the ear piercing. Notes from home are NOT acceptable.
3. While customer is filing out & SIGNING their portion of the release form you can gather the selected earrings and all the necessary supplies, including:
 - Earrings
 - Ear Magic
 - Cotton Swabs
 - Skin Scribe Marking Pen
 - Ear Piercing Instrument
 - Mirror
 - Hair pins or clips
 - Wipes
 - Surgical gloves
4. Wash / Clean Hands with Ear Magic, antiseptic rubbing alcohol, soap or antiseptic and put on surgical gloves. Clean instrument with 70% Isopropyl Alcohol. Replace gloves with a sterile pair.
5. Clean and mark the customer's ears:
 - a.) Use hair pins or clips to pull hair up and away from lobes.
 - b.) Cleanse lobes, front and back, using Ear Magic or 70% Isopropyl Alcohol & cotton swab (or Ear Magic Wipe.) NEVER RE-DIP SWAB once it has touched the ear.
 - c.) Check lobes for Keloids, cysts or any other abnormalities. If found, do not pierce.
 - d.) Using skin scribe marking pen, place dots on the ear lobes where you will pierce.
 - e.) Hand customer the mirror to view the dots. If customer is a minor, you must have the legal guardian approve the dots. Feel free to ask others in the customer's group to keep them involved!
 - f.) If customer is not satisfied, wash off dots with Rubbing Alcohol and start again at step c. Repeat until customer approves.

HINT: If you need to redo the dots, use a clean cotton swab dipped in rubbing alcohol to remove the dots. Use the DRY side of the swab to "dry the lobe" before you dot again. (This keeps your dot from "running".)



In order to focus on our core business, Concepts will no longer be offering Ear Piercing Products.
We are providing this previously written manual to assist in this transition.
For use of the Studex Universal Instrument, Please refer to Studex for Manuals & Videos:
studex.com 1-800-478-8339 or 1-310-851-9300

HOW TO MARK THE EARS

The mark should go in the center of the lobe.

ALWAYS MAKE SURE YOUR CUSTOMER APPROVES THE DOTS BEFORE PROCEEDING. Remove dots with a cotton swab and rubbing alcohol, dry, and redo as many times as needed prior to proceeding!



Second holes often go up on an angle.

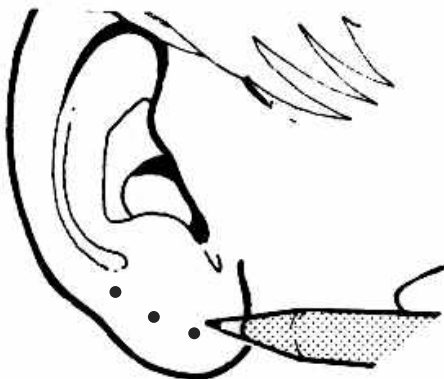
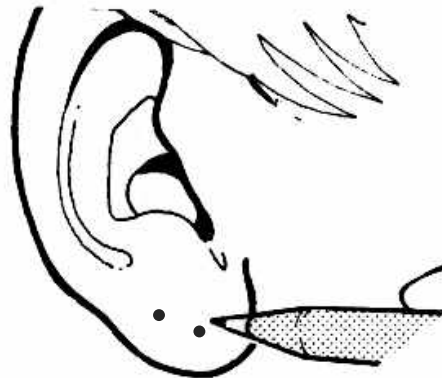

ONLY pierce through the FLESHY part of the ear lobe. Usually three holes is the maximum that will fit.
DO NOT PIERCE CARTILAGE.

In order to focus on our core business, Concepts will no longer be offering Ear Piercing Products.
We are providing this previously written manual to assist in this transition.
For use of the Studex Universal Instrument, Please refer to Studex for Manuals & Videos:
studex.com 1-800-478-8339 or 1-310-851-9300

6. Click the **unloaded** ear piercing instrument, to demonstrate the sound it will make when you actually pierce. Pull the knob Back, then pull in the trigger, This will prepare the customer for the noise so she or he won't jump!

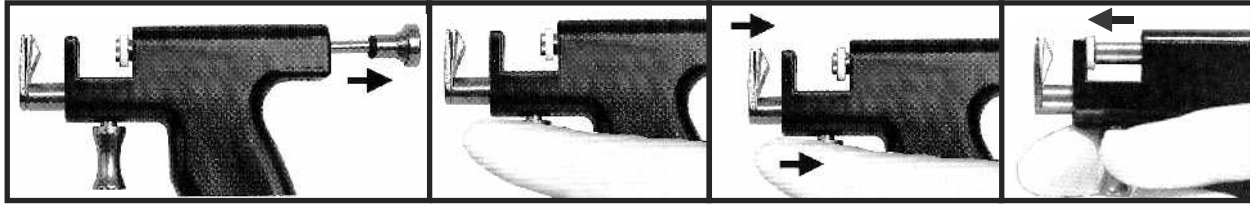

a.) Pull knob out to cock the instrument

b.) Wrap finger around the "Trigger"

c.) If you gently squeeze the "Trigger" the end of the instrument will move in closer.

d.) Then when you are ready to pierce you give it a big pull!

7. Cock the instrument once again to prepare for loading. (Figure a.)

Get the chosen Ear Piercing Earring out and ready for piercing...

8. Lift one corner of the paper backing away from the bubble pack, peel off slowly, taking care not to let wand pop out when you release the paper backing.

e.)

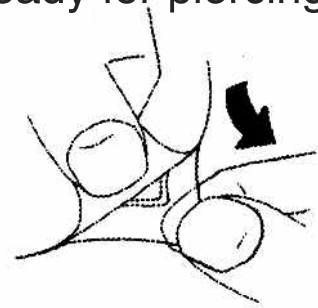

9. Hold the plastic bubble in the hand you will use to pierce. To remove the wand, bend the bubble pack down, away from the wand. You can then grasp the wand with your other hand, and remove it without touching either part of the earring. Each earring is sterilized within the bubble pack, and the earring can not be touched prior to piercing.
(See figures f. and g.)

f.)

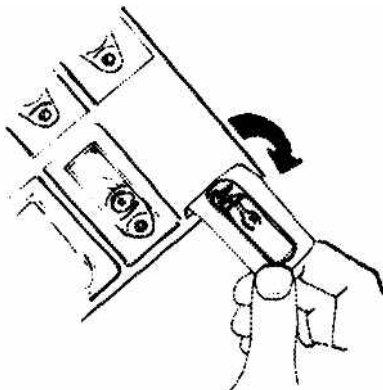

g.)

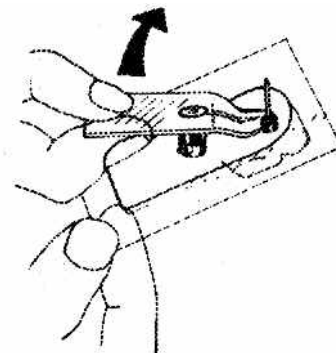

HINT: Make your customer feel at ease by telling her/him what you are doing, talk about the weather, or your current special offer on beautiful fine jewelry!



In order to focus on our core business, Concepts will no longer be offering Ear Piercing Products.
We are providing this previously written manual to assist in this transition.
For use of the Studex Universal Instrument, Please refer to Studex for Manuals & Videos:
studex.com 1-800-478-8339 or 1-310-851-9300

Now it's time to Load the Instrument!

First Load the "Back"

10. Holding the plastic piece in one hand, and the instrument in the other, point the instrument upwards at a slight angle. Position the earring BACK in the slot on the very end of the instrument. The flat side of the earring BACK should be facing the instrument and the loops should be facing out the back. Slide in the back See Figures a.) & b.)

11. Gently "pry" the wand loose once the earring BACK is in place by pulling up and away on the plastic piece. See Figure c.) & d.)

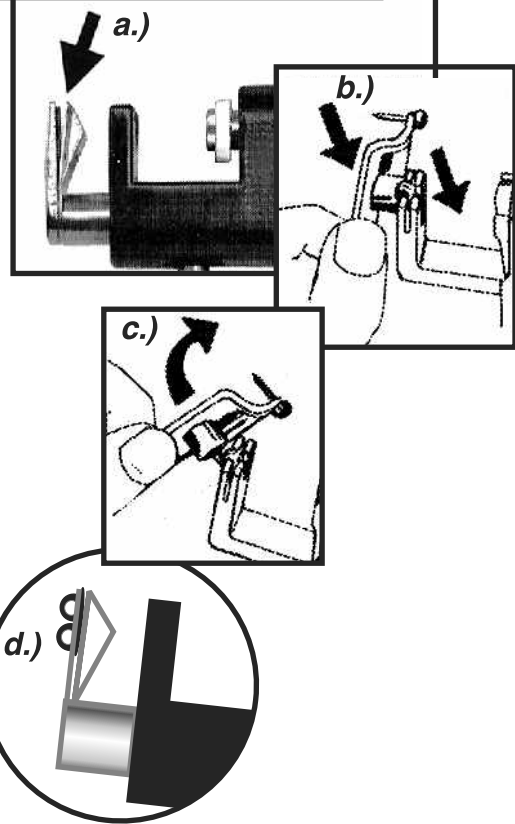

Test Earring fit to Adapter Before Using

Insert earring into Adapter without removing from wand, pull earring in & out a few times to make sure it comes out easily. IF Earring does not easily go in & out of the instrument do not use earring. If several different styles fit too snugly in the instrument, please contact Studex for replacement instrument: 1-800-478-8339 www.studex.com

Now Load the "Front"

12. Still pointing the instrument upwards at a slight angle, put the earring FRONT into the barrel hole. Once the FRONT is in place, gently "pry" loose the plastic piece up and back. (Discard the plastic piece.)

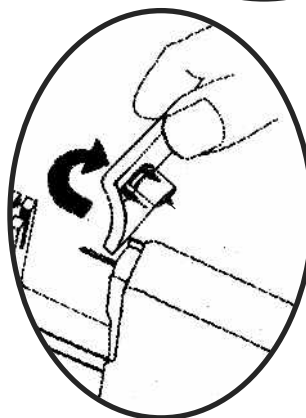

f.) pry back plastic piece to remove

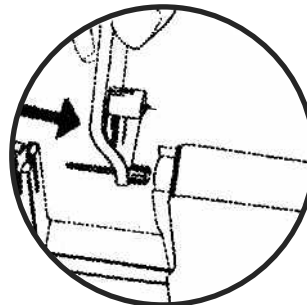

e.) front in



HINT: Keep the instrument pointed upwards while loading the front and back.

In order to focus on our core business, Concepts will no longer be offering Ear Piercing Products.
We are providing this previously written manual to assist in this transition.
For use of the Studex Universal Instrument, Please refer to Studex for Manuals & Videos:
studex.com 1-800-478-8339 or 1-310-851-9300

13. Bring the instrument up around the lobe so the lobe is between the clamp holder and the earring point. Now, carefully align the point of the stud with the mark on the ear lobe. The earring should be level so when you do pierce the ear, the canal will be nice and straight. Gently pull the trigger to bring the lobe closer to the point, then when you are ready SQUEEZE the trigger hard. Then the ear will be pierced!

POINTS OF IMPORTANCE:

Allow ear lobe to remain in its natural position - don't pull it out of shape.

14. Release the trigger and carefully lower the instrument straight down from the ear.

15. REPEAT for other Ear!

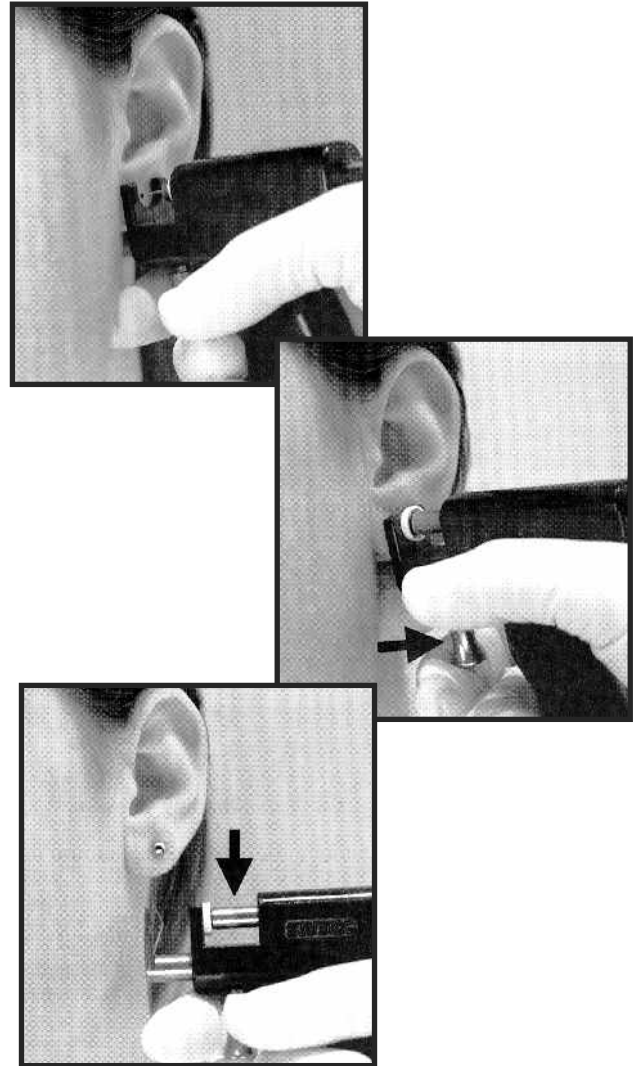

16. HAVE CUSTOMER REMAIN SEATED.
You can hand them a mirror to view their newly pierced ears. Compliment the customer on her or his new ear piercing. Try to go all the way through Step 19 so your customer remains seated for no less than 2 minutes.

In order to focus on our core business, Concepts will no longer be offering Ear Piercing Products.
We are providing this previously written manual to assist in this transition.
For use of the Studex Universal Instrument, Please refer to Studex for Manuals & Videos:
studex.com 1-800-478-8339 or 1-310-851-9300

17. **CLEAN THE EARS AND EARRINGS** While Showing Your Customer How to Perform these tasks. Instruct your customer to watch you using the hand mirror. Be sure to tell your customers to:

- a. Clean their ears twice a day with Ear Magic (Use Customer's bottle.)
- b. First saturate one end of the swab (dip cotton swab in Ear Magic.)
- c. Gently push earring from back and clean between earring and ear lobe. (Dip the clean side of the swab.) Do the same between the earlobe and earring back.
- d. Instruct Customer, while referring to your ear care card or care instructions on the release form:
 - Do not twist or turn the earrings, just push forward and back to clean.
 - Do not remove the studs for the first 6 weeks.
 - Be careful to not snag earrings on clothing, towels or by other means.
 - Cosmetics & hair spray should not come in contact with earlobes. Cover earlobes with hand or paper cup when using sprays.
 - Clean after swimming, showering, heavy exercise or if lobes become soiled between cleaning.

-WEAR STUDS 4-6 WEEKS WITHOUT REMOVING.

After removing the first time, do not go without earrings for the next 12 months.

-Avoid wires for 6 months and always avoid heavier styles.

-Continue to clean ears twice daily with Ear Magic.

-Do not wear earrings too tightly.

-If lobes should become irritated you may be having an allergic reaction to the nickel used in making fashion and 14Kt gold pierced earrings. In case of injury or irritation, reinsert piercing studs until healed and consult your doctor.

-Concepts® Earrings for Sensitive Ears are made non-irritating for sensitive ears.

-If you sell Concepts earrings in your store, point out your Concepts® display!!

NOTE: POINT OUT THE EAR CARE INSTRUCTIONS ON YOUR EAR CARE CARD AND/OR RELEASE FORM COPY. Now it's time to wrap up the procedure:

18. Quickly discard used plastic loading pieces, swabs, etc, clean instrument and area with 70% or higher Isopropyl Rubbing Alcohol. Ear Magic. Remove gloves.

19. Give customer the white copy of the release form, other promotional materials such as a 20% off Concepts Coupon, or your stone of the month coupon, and an EAR CARE CARD. You may want to set up ear care appointments on the top of the card. By this time the customer should be okay to stand up. Ask them "ready to stand up?" If not, have them remain seated a while longer - you can show and sell your favorite pieces of fine jewelry while they relax!!

20. **SHOW AND SELL YOUR FINE JEWELRY** and Concepts Earrings for Sensitive Ears!!

NOTE: Concepts "Pearl Post Cards" thank customers for getting their ears pierced at your store and offer them a FREE sample pair of Concepts Earrings when they return. Sample Concepts Earrings #82106 are available from \$2.35/pair US in quantities. Concepts sim. Pearl Post Cards with this offer are no charge with purchase. You may mail the card about 1-2 weeks after piercing using the address on the release form, or hand the card to the customer on the day of piercing before the customer leaves.

Congratulations!

In order to focus on our core business, Concepts will no longer be offering Ear Piercing Products.
We are providing this previously written manual to assist in this transition.
For use of the Studex Universal Instrument, Please refer to Studex for Manuals & Videos:
studex.com 1-800-478-8339 or 1-310-851-9300

Concepts[®]

Fas-Load[®]

Ear Piercing Earrings

Questions & Answers

Q. Is there an age limit for ear piercing?

A. Yes. DO NOT pierce babies. We recommend that the child be 3 years of age or older. Some stores adopt the policy that the child has to be able and willing to tell the piercer that she or he wants to get her or his ears pierced.

Q. How high on the ear can be pierced?

A. Only pierce through the fatty part of the ear lobe. Under NO circumstances should you pierce through the cartilage.

Q. Does ear piercing take a lot of time?

A. Ear Piercing should take less than 15 minutes. To save time, gather supplies when customer is choosing her or his ear piercing style, and prepare for piercing when customer is completing the release form.

Q. What if a child changes her or his mind after the first ear is pierced?

A. We recommend that the sales person tell the child how great she or he did today and invite her or him to come back whenever she or he is ready to have the other ear pierced.

A few other notes on this subject:

- The parent should be told in advance that if the child changes her or his mind after one ear, the second one will have to wait until the child is ready. Most parents will understand this.
- Keep treats or prizes for the young children, and give them their prize even if they don't get both of their ears done.
 - Don't tell the child that this 'won't hurt a bit'. It WILL sting for about one minute, and you have a better chance of getting the second ear done if the child trusts you.
 - Stock 2 instruments in your store so two staff members pierce at the same time!

Q. Does ear piercing hurt?

A. It DOES sting, for about 1 minute, then it will feel warm and tingly for several minutes afterwards.

Q. What if my ear piercing instrument breaks.

A. Replacement Studex instruments may be purchased directly from Studex: 1-800-478-8339 or 1-310-851-9300 www.studex.com

In order to focus on our core business, Concepts will no longer be offering Ear Piercing Products.
We are providing this previously written manual to assist in this transition.
For use of the Studex Universal Instrument, Please refer to Studex for Manuals & Videos:
studex.com 1-800-478-8339 or 1-310-851-9300

IMPORTANT:

Be sure to confirm with your Town or City, State and County Health Department that no additional restrictions, license or permit is required to offer ear piercing in your area. If so, follow the additional processes to ensure you are compliant with your local health department.

IMPORTANT EMPLOYEE / TRAINING INFORMATION

You must offer a hepatitis "B" Vaccination to all employees that will pierce, per OSHA regulations. You must have employees that will pierce sign a statement pertaining to this.

Do not require reluctant employees to pierce.

You must supply a sanitary work environment and the following tools: disposable surgical gloves, antiseptic such as Rubbing Alcohol and Concepts Ear Magic and a covered trash can.

Instruct employee to review all information in manual until he/she understands fully.

Have trainee practice on practice pad until able to hit the purple dot each and every time.

Work with trainee over and over. Have trainee demonstrate to you to insure they are operating the instrument correctly and fully understand all instructions.

Ask trainee each point in the manual to make sure they understand. Have the trainee pretend that they are piercing an associate's ears without an earring in the instrument. Watch the trainee closely to make sure they are following each procedure correction. Continue practicing until trainee is able to do correctly each and every time.

You may consider bringing in a volunteer or two to have their ears pierced. Supervise the trainee's first few ear piercings until you know they are 100% capable of piercing on their own.

CONCEPT MARKETING, INC.
1000 Arendell St. • Morehead City, NC 28557
www.conceptsjewelry.com
info@conceptsjewelry.com
Phone: 1-800-926-3277 Fax: 1-800-247-7290

Concepts[®]
for Sensitive Ears

*Customers LOVE Using
this easy Add On Sale!*

Ear Magic

**Antiseptic for the care of
Pierced Ears and Earrings!**

Ear Magic is used to care for pierced ears and earrings. It is made with no perfumes or colors. Active ingredient: Benzalkonium Chloride (U.S.P. 1:1000)

- *Safe for Sensitive Ears*

Ear Magic is safe for Sensitive Ears. It also does not Sting, does not have a strong 'scary' smell, and will not stain!

- *Great Traffic Builder*

A bottle of **Ear Magic** should last 2-8 weeks, which means the customer will be returning to **YOUR STORE** at least that often to purchase **Ear Magic** and other items your store carries!

- *Gentle Jewelry Cleaner*

Ear Magic is great for daily cleaning of pierced earring posts, Gentle & Effective. It's even safe for delicate pearls and opals!

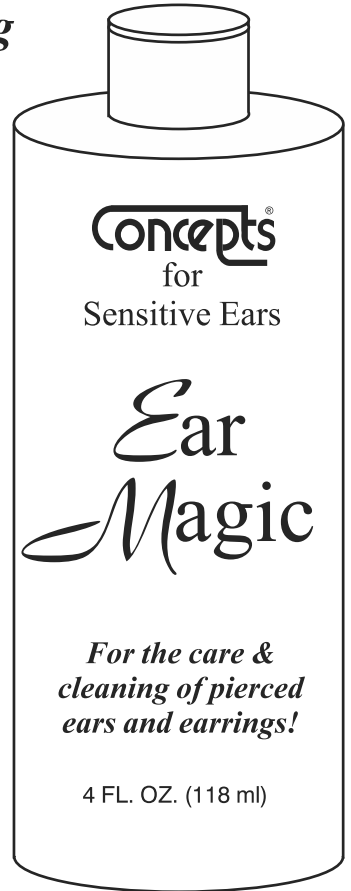

*Proudly
Made in the
USA!*

*For the care &
cleaning of pierced
ears and earrings!*

4 FL. OZ. (118 ml)

| ORDER | QTY | # BOTTLES | COST EACH | TOTAL COST |
|-------|--------|-----------|-----------|------------|
| _____ | 1 Case | 72 | \$1.95 | \$140.40 |
| _____ | _____ | _____ | \$2.50 | _____ |



*Manufacturer's
Suggested
Retail \$6.95*

ORDER DATE ____/____/____

SHIP TO: _____

BILL TO: (IF DIFFERENT THAN ABOVE)

ABOVE IN US FUNDS
FOR CANADIAN FUNDS
MULTIPLY BY 1.65

ONLY THE BEST... Concepts[®]
*Your Satisfaction
is Our Guarantee
Since 1973*

Concept Marketing inc.

1000 Arendell St. • Morehead City, NC 28557
info@conceptsjewelry.com www.concept-marketing-inc.com

FAX: 1-800-247-7290

PHONE: 1-800-926-3277

IMPORTANT NOTIFICATION

**In order to focus on our core business,
Concepts will no longer be offering Ear Piercing Products.**

We are providing this previously written manual to assist in this transition.

For use of the Studex Universal Instrument,
Please refer to Studex for Manuals & Videos:
studex.com 1-800-478-8339 or 1-310-851-9300

Replacement Universal Studex instruments
may be purchased directly from Studex:
1-800-478-8339 or
1-310-851-9300
www.studex.com

CONCEPT MARKETING, INC.
1000 Arendell Street
Morehead City, NC 28557

Phone: 1-800-926-3277
Fax: 1-800-247-7290
Text: 1-252-723-2234

www.conceptsjewelry.com
info@conceptsjewelry.com